

# UE1800-D



## Ni-MH rechargeable cylindrical cell (Data Sheet)

### Specification

Nominal Voltage		1.2V	
Dimensions	Diameter	32.2±0.2mm	
	Height	61.2±0.3mm	
	Apx. Weight	76g	
0.2C Discharge Capacity	Typical	1850mAh	
	Minimum	1800mAh	
Typical Internal Impedance		Less than 10mΩ	
Charge	Standard	180mA for 16hrs	
	Fast	900mA for about 150min	
Life expectancy		500 cycles	
Operating Temperature	Charge	Standard	0°C to 40°C
		Fast	10°C to 40°C
	Discharge		-10°C to 50°C
	Storage	< 1 year	-10°C to 30°C
< 3 months		-10°C to 40°C	

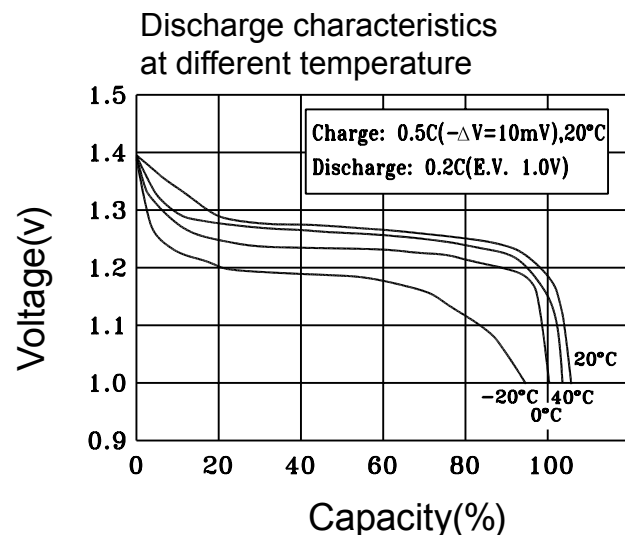
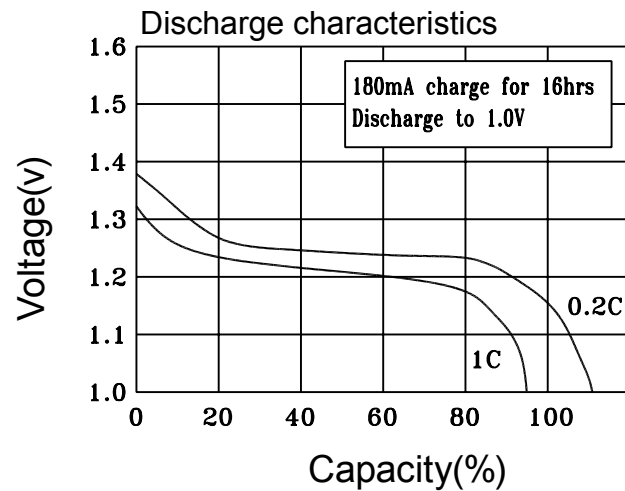
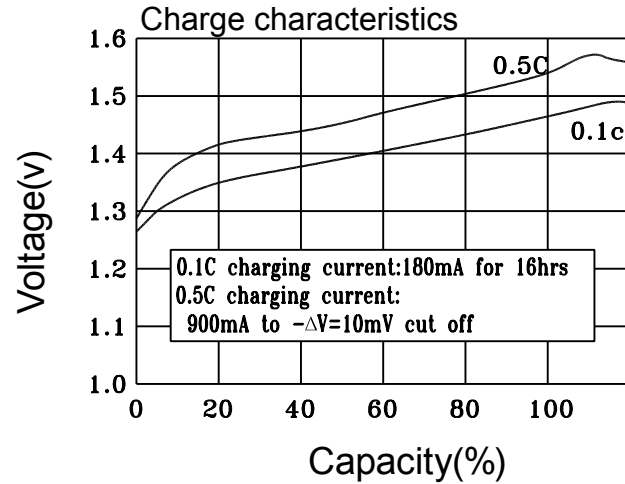

### Cell dimensions

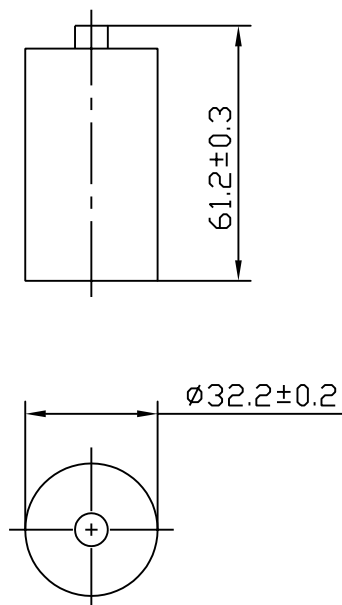

(With tube)

1:1