

CR2025

Lithium coin cell (Data Sheet)

Specification

Model	CR2025
Nominal voltage	3.0(V)
Nominal capacity	140(mAh)
Standard discharge current	0.2(mA)
Maximum recommended current unde continuous discharge	4.0(mA)
Maximum recommended current unde pulse discharge	12(mA)
Operational temperature range	-20~60(°C)
Nominal weight	2.5(g)

Temperature Characteristics

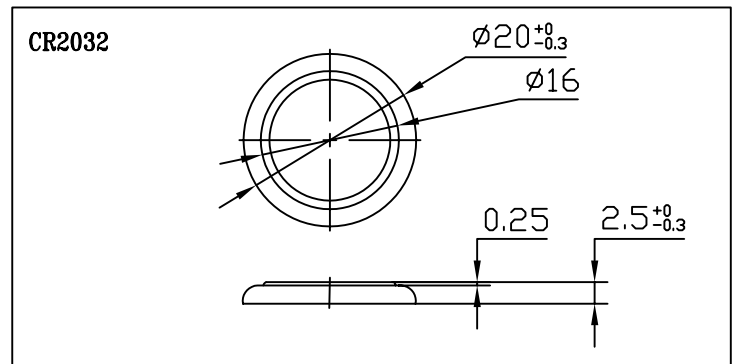
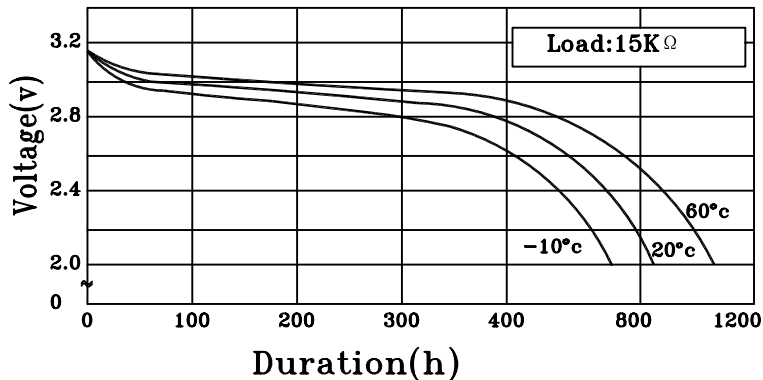

Untagged Battery Dimensions

Operating voltage vs. load resistance (voltage at 50% discharge depth)

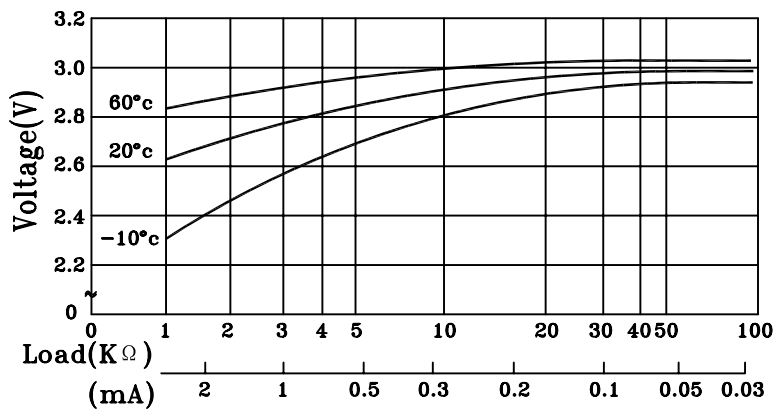

Capacity vs. load resistance

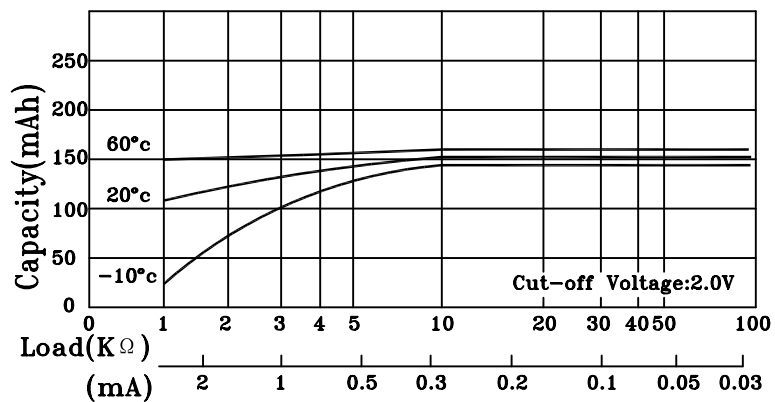

Main Features

- Light Weight, High Voltage and High Energy Density
- Excellent Stable Discharge Characteristics and outstanding Temperature Characteristics
- Outstanding Temperature Characteristics
- Excellent Leakage Resistance and excellent Long-term Reliability